

IEG1-36034-10-V

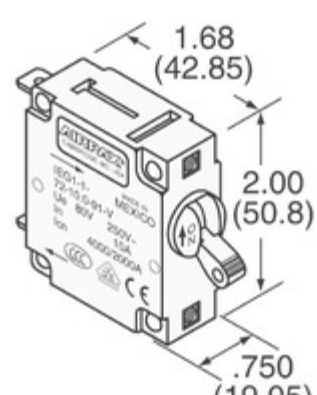

Obrázky jsou pouze orientační.
Podrobné informace o produktu naleznete v části Technické údaje produktu.
Koupit IEG1-36034-10-V s důvěrou od Component-World.HK, 1 rok záruka



Part Number: [IEG1-36034-10-V](#)

Výrobce: [Sensata Technologies, Airpax](#)

Popis: CIR BRKR MAG-HYDR LEVER

Datový list: [IEG, IUG, JEG, CEG, LEG Series Datasheet](#)

RoHS Status: Bez olova / V souladu RoHS

Ship From: Hong Kong

Shipment Way: DHL/Fedex/TNT/UPS/EMS

[Request For Quotation](#)









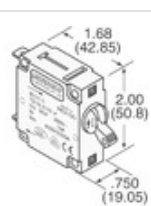
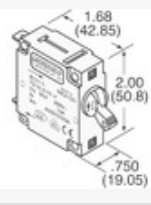
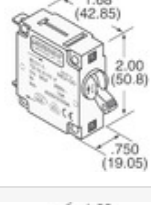

PARAMETR PRODUKTU

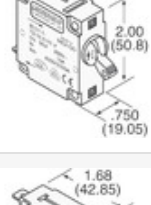
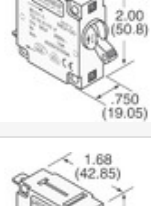
Part Number	IEG1-36034-10-V	Výrobce	Sensata Technologies, Airpax
Popis	CIR BRKR MAG-HYDR LEVER	Stav volného vedení / RoHS	Bez olova / V souladu RoHS
Dostupné množství	3075 pcs	Datový list	IAG,IUG,JEG,CEG,LEG Series Datasheet
Kategorie	Ochrana obvodu	Série	IEG
Počet pólu	1	Typ montáže	Panel Mount
Úroveň citlivosti na vlhkost (MSL)	1 (Unlimited)	Výrobní standardní doba výroby	6 Weeks
Stav volného vedení / RoHS	Lead free / RoHS Compliant	Osvětlení napětí (nominální)	-
Osvětlení	-	Jmenovitá hodnota proudu	-
Breaker Typ	Magnetic (Hydraulic Delay)	Pohon Type	Lever

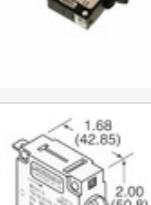
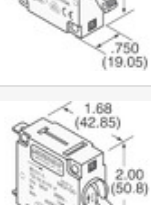
Component-World.com je spolehlivý distributor elektronických součástek. Specializujeme se na všechny elektronické komponenty řady Sensata Technologies, Airpax. Máme 3075 kusy Sensata Technologies, Airpax IEG1-36034-10-V na skladě dostupných. Vyžádejte si citát z distributora součástí elektroniky na Component-World.com, náš prodejní tým vás bude kontaktovat do 24 hodin.

RFQ Email: info@Components-World.com

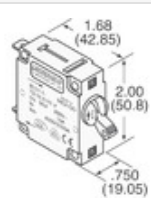
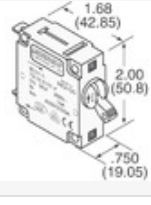
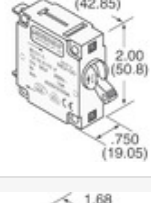
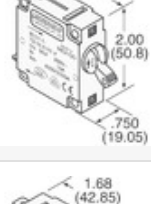
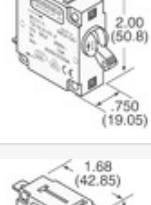
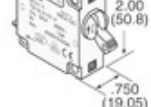
SOUVISEJÍCÍ PRODUKTY

	Část#: IEG1-36072-7-V Výrobci: Sensata Technologies, Airpax	Dotaz
	Část#: IEG1-35634-5-V Výrobci: Sensata Technologies, Airpax	Dotaz
	Část#: IEG1-36072-4-V Výrobci: Sensata Technologies, Airpax	Dotaz
	Část#: IEG1-36446-30-V Výrobci: Sensata Technologies, Airpax	Dotaz
	Část#: IEG1-36211-20-UV Výrobci: Sensata Technologies, Airpax	Dotaz
	Část#: IEG1-36446-5-V Výrobci: Sensata Technologies, Airpax	Dotaz
	Část#: IEG1-36212-15-V Výrobci: Sensata Technologies, Airpax	Dotaz
	Část#: IEG1-36211-15-UV Výrobci: Sensata Technologies, Airpax	Dotaz
	Část#: IEG1-35634-4-V Výrobci: Sensata Technologies, Airpax	Dotaz
	Část#: IEG1-35628-7-V Výrobci: Sensata Technologies, Airpax	Dotaz
	Část#: IEG1-35699-1-V Výrobci: Sensata Technologies, Airpax	Dotaz
	Část#: IEG1-35994-20-V Výrobci: Sensata Technologies, Airpax	Dotaz
	Část#: IEG1-35628-4R5-V Výrobci: Sensata Technologies, Airpax	Dotaz
	Část#: IEG1-36446-15-V Výrobci: Sensata Technologies, Airpax	Dotaz
	Část#: IEG1-36034-6-V Výrobci: Sensata Technologies, Airpax	Dotaz
	Část#: IEG1-36072-6-V Výrobci: Sensata Technologies, Airpax	Dotaz
	Část#: IEG1-35994-30-V Výrobci: Sensata Technologies, Airpax	Dotaz
	Část#: IEG1-35628-5-V Výrobci: Sensata Technologies, Airpax	Dotaz
	Část#: IEG1-35699-2-V Výrobci: Sensata Technologies, Airpax	Dotaz
	Část#: IEG1-35628-25-V Výrobci: Sensata Technologies, Airpax	Dotaz

Související klíčová slova pro IEG1-36034-10-V

Sensata Technologies, Airpax IEG1-36034-10-V.	IEG1-36034-10-V distributor	IEG1-36034-10-V dodavatel	IEG1-36034-10-V Cena
IEG1-36034-10-V Stáhnout datasheet.	IEG1-36034-10-V Datasheet.	IEG1-36034-10-V Stock.	koupit IEG1-36034-10-V.
Sensata Technologies, Airpax IEG1-36034-10-V.	Sensata Technologies/Airpax IEG1-36034-10-V.		